

SHADOWLINE TRIM

SERIES BY **ME**TRIM

INSTALLATION WINDOWS AND DOORS PLASTER TRIM

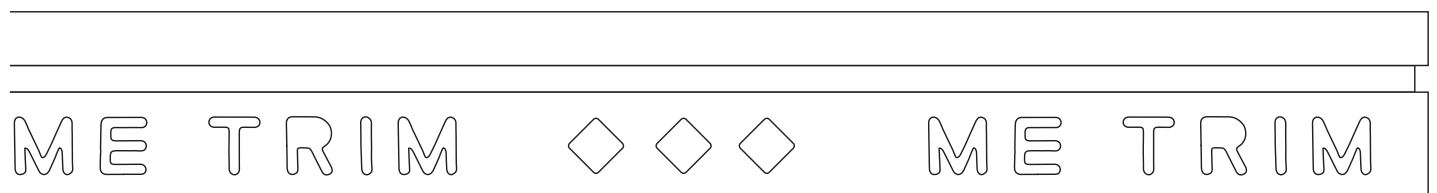

SHADOWLINE TRIM

This installation guide offers comprehensive instructions for fitting ME TRIM trim around doors, windows, and corners, suitable for both Windows and Doors. It details preparation, necessary tools, and provides step-by-step directions for measuring, cutting, and securing the trim to ensure professional results. The guide emphasises proper techniques and includes customer service support for additional help and personalised consultations.

BEFORE YOU START!!

Please note that all ME TRIM products are supplied with a protective film. This should not be removed until painting of the jambs are complete.

Window and Door Jambs are to be installed prior to install ME TRIM.

PLASTER TRIM

WINDOW TRIM

PREPARATION

Before beginning ME TRIM installation, it is important that the window frame and jamb is prepared correctly. Please see below to ensure your window frame is correct before installing your ME TRIM Shadowline Trim.

WINDOW FRAME

Window frame and jamb must be installed prior to install trim.

Install trim around all sides.
Recommended to use a adhesive polymers and screw for strongest results.

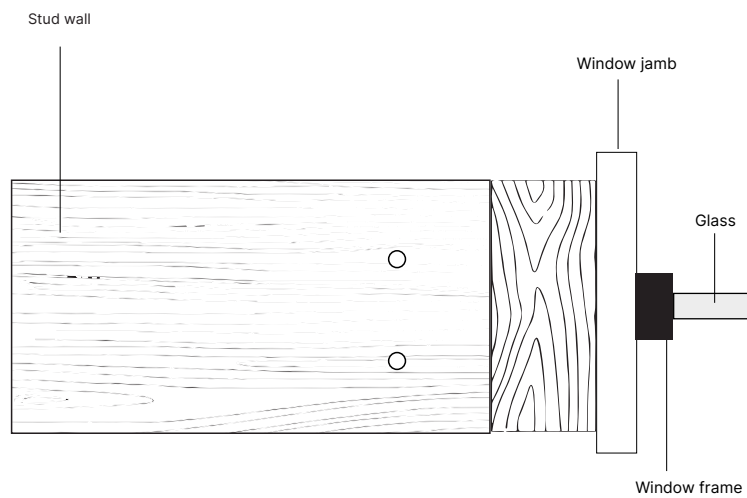

PLASTER TRIM

WINDOW TRIM

REQUIRED TOOLS - NOT SUPPLIED



EAR PROTECTION



EYE PROTECTION



12MM PACKER STRIP



PENCIL

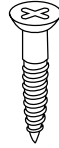

25MM SCREWS

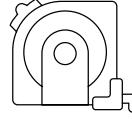

TAPE MEASURE

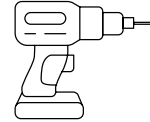

DRILL

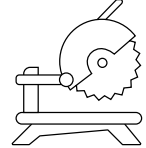

DROP SAW

STEP 1

Measure window jamb. Take your measurement from the outside of the window jambs.

Mark your measurements on your ME TRIM shadowline trim.

This example uses Box Series ME TRIM.

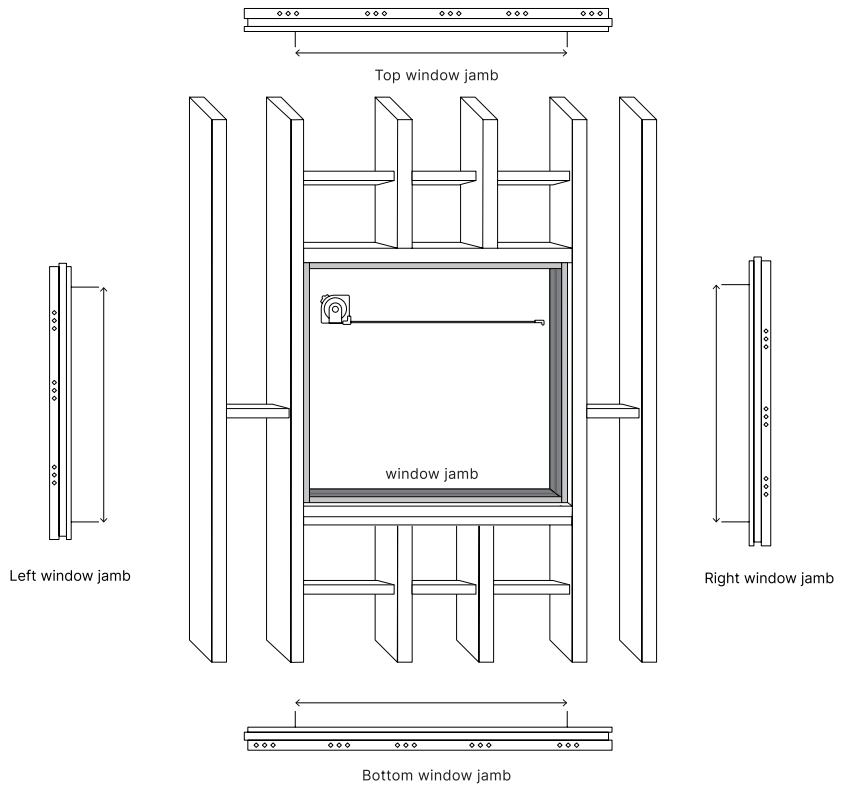

Make sure to make your mark on the edge of the ME TRIM closest to inside of the window (as pictured).

*The side with the screw holes will face away from the window frame on each side with the top of the "M" on ME TRIM facing the inside of the window.

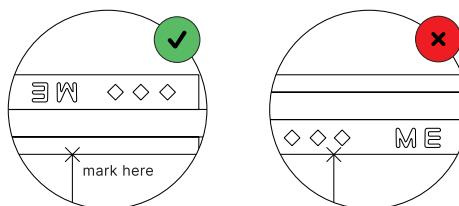

PLASTER TRIM

WINDOW TRIM

STEP 2

Place your top window jamb ME TRIM length on the drop saw table.

Before cutting ensure your blade is sharp, your dropsaw is straight and at a perfect 45° angle.

Using the drop saw, prepare cutter to 45° angle and cut at 45° on both sides.

Once cut, the longest part of your ME TRIM length should be the side with the screw holes.

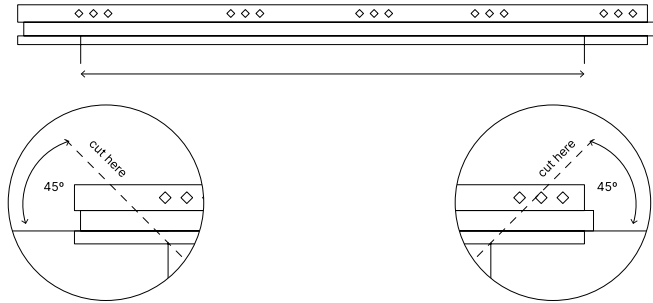

STEP 3

Repeat the cutting process on the left, right and bottom window jamb ME TRIM lengths.

Make sure the side with the screw holes is facing away from the window on each side.

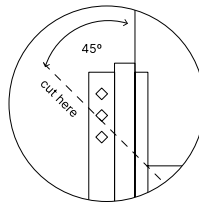
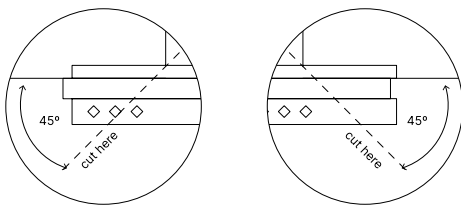
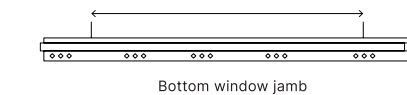

Left window jamb

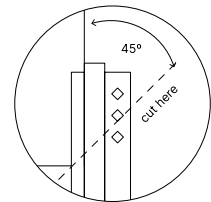

Right window jamb

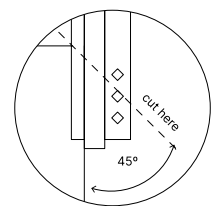
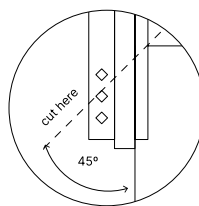

ALTERNATIVE CUT METHOD

ME TRIM can alternatively be cut at a 90° angle. After measuring and cutting the length of the window frame, and addition pieces is cut from one side of the join and the second trim is placed flush adjacently. If this method is preferred, please measure and cut accordingly. This only applies at BOX and L Series trim.

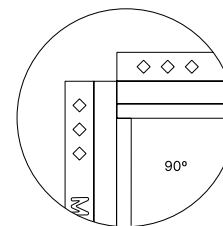
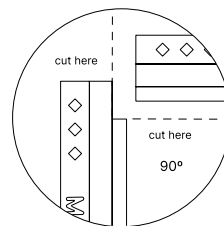

STEP 4

Fit the ME TRIM to the timber building window jamb, the ME TRIM logo and screw holes are to be on the face of the timber building frame.

Using 25mm screws to fix the ME TRIM plaster to the timber building window frame. The screws must penetrate the wood window frame, it is recommended to use 1 × 25mm self tapping screws every 50cm and using an adhesive polymer under the trim between the trim and frame.

NB. For a stronger fixing, it is recommended—but not mandatory—to apply polyurethane adhesive for initial positioning of the trims before securing them with screws.

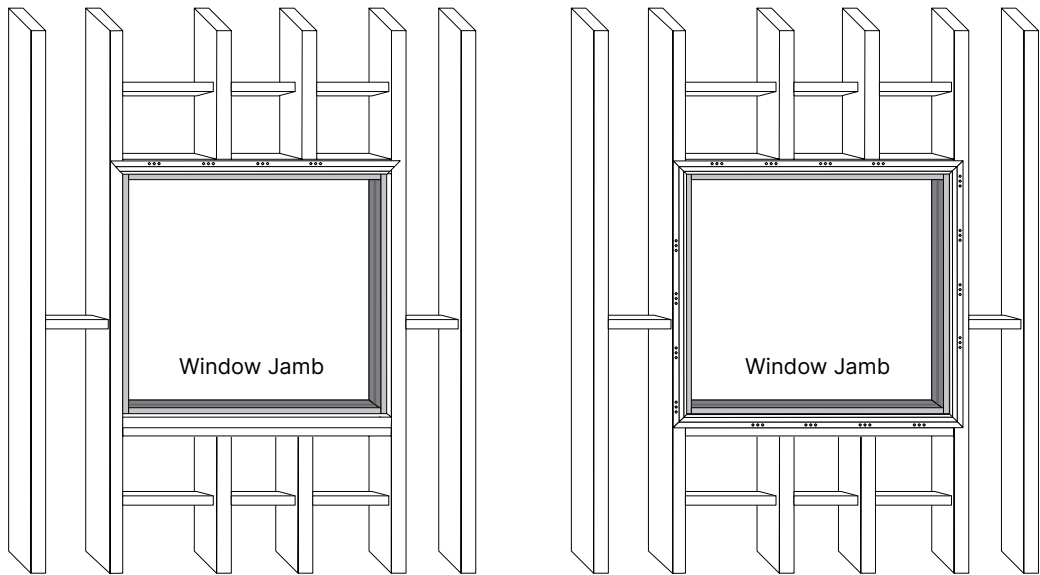
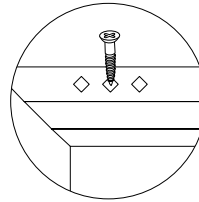

STEP 5

Once the ME TRIM is fixed to the timber building window jamb, plaster the area around the window slide the plaster into the ME TRIM plaster trim on all sides.

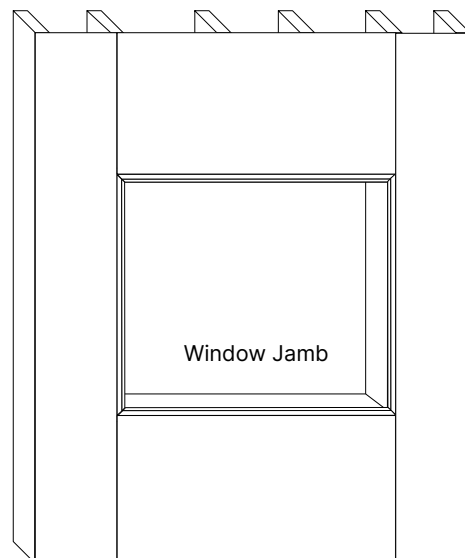

PREPARATION

Before beginning ME TRIM installation, it is important that the door jamb is prepared correctly. Please see below to ensure your frame and door jambs is correctly installed for your ME TRIM Shadowline Trim.

DOOR FRAME

Door jamb must be installed prior to install trim, either flush to the frame or packed out.

Install trim around all sides. Recommended to use a adhesive polymers and screw for strongest results.

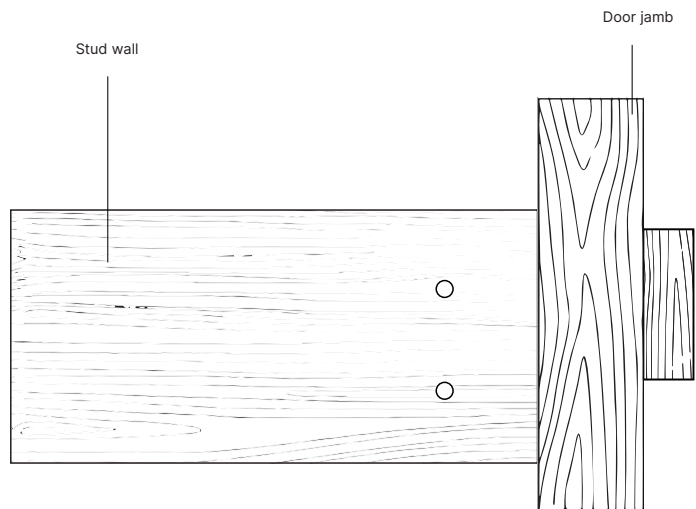

PLASTER TRIM

DOOR TRIM

REQUIRED TOOLS - NOT SUPPLIED



EAR PROTECTION



EYE PROTECTION



12MM PACKER STRIP



PENCIL

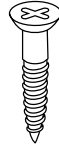

25MM SCREWS

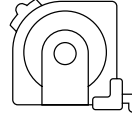

TAPE MEASURE

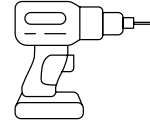

DRILL

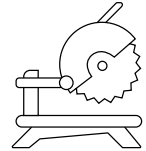

DROP SAW

STEP 1

Once your jamb is installed measure door jamb. Take your measurement from the outside of the door jambs.

Mark your measurements on your ME TRIM shadowline trim.

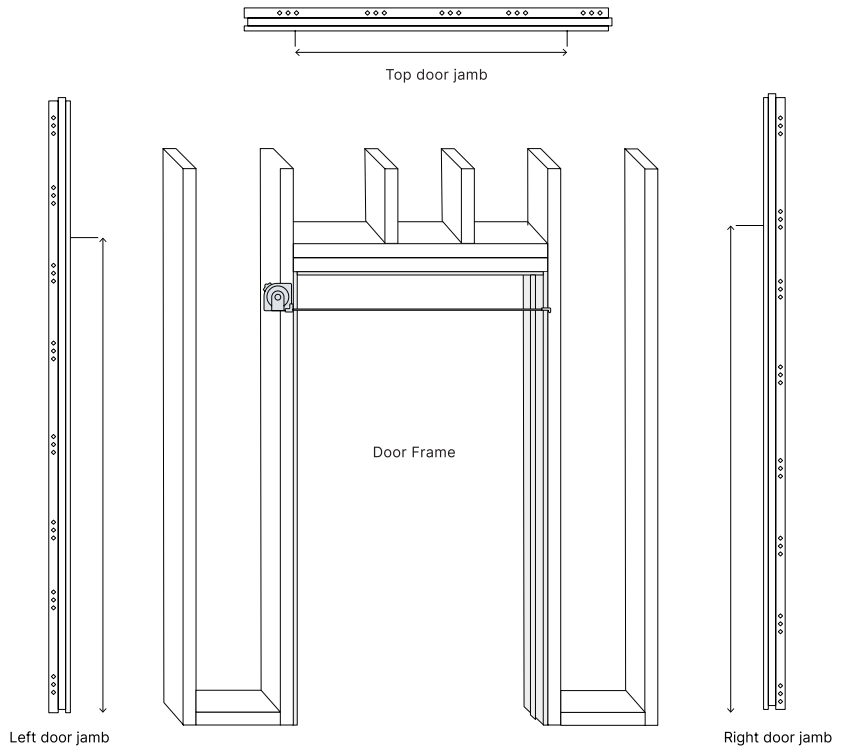

This example uses Box Series trim.

Make sure to make your mark on the edge of the ME TRIM closest to inside of the door (as pictured).

*The side with the screw holes will face away from the door frame on each side with the top of the "M" on ME TRIM facing the inside of the door.

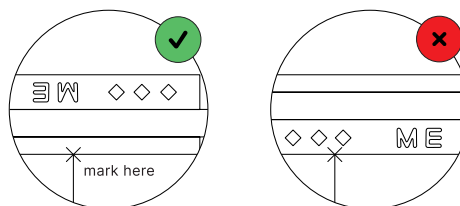

PLASTER TRIM

DOOR TRIM

STEP 2

Place your top door jamb ME TRIM length on the drop saw table.

Before cutting ensure your blade is sharp, your dropsaw is straight and at a perfect 45° angle.

Using the drop saw, prepare cutter to 45° angle and cut at 45° on both sides.

Once cut, the longest part of your ME TRIM length should be the side with the screw holes.

Start Left, right then top.

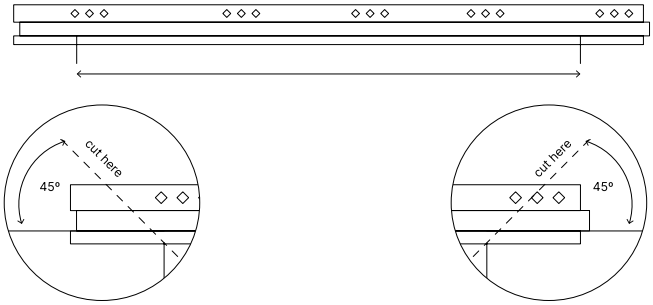

STEP 3

Repeat this step, cutting the side lengths of your ME TRIM.

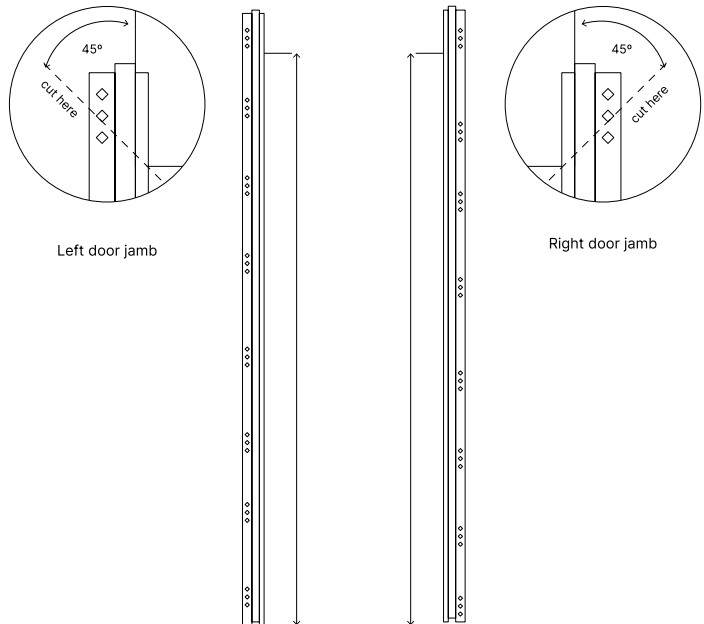

ALTERNATIVE CUT METHOD

ME TRIM can alternatively be cut at a 90° angle. After measuring and cutting the length of the door frame, and addition pieces is cut from one side of the join and the second trim is placed flush adjacently. If this method is preferred, please measure and cut accordingly. This only applies at BOX and L Series trim.

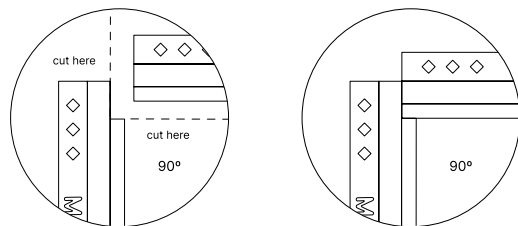

PLASTER TRIM

DOOR TRIM

STEP 4

Fit the ME TRIM to the timber building door frame, placing the inner side of ME TRIM next to the door jam and the timber building door frame ready to fix.

The ME TRIM logo and screw holes are to be on the face of the timber building frame.

Using 25mm screws to fix the ME TRIM to the timber building door frame. The screws must penetrate the wood door frame, it is recommended to use 1×25mm self tapping screws every 50cm.

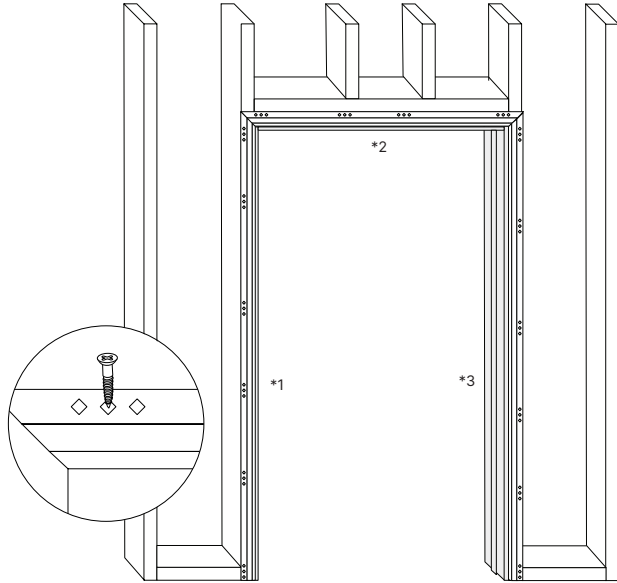

* Install order: 1, 2, 3

STEP 5

Once the ME TRIM tile trim is fixed to the timber building door frame, plaster the area around the doorway slide plaster in from the left-hand-side first into the ME TRIM and repeat from right hand side.

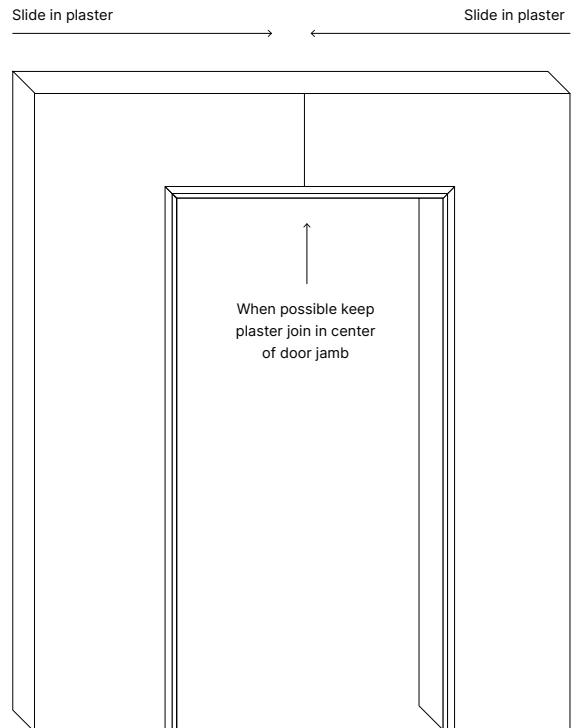

PLASTER

DOOR

STEP 5 (TWO DOORS)

You could be faced with two doorways next to each other, in this case the process of install is different.

First start by cutting all your lengths for each door. Then install the first frame starting on the left. Once the first ME TRIM is installed install plaster around the first doorway starting left to right.

With the plaster install on the first door all the way up to the second door jamb (1&2), Keep the plaster at the second jamb unglued, slot the ME TRIM under the plaster applied adhesive polymers and screw through the plaster into the trim and to the frame.

Once the left hand side trim of the second door is in complete the install of the trim right and top sides. (3) Slide plaster into place.

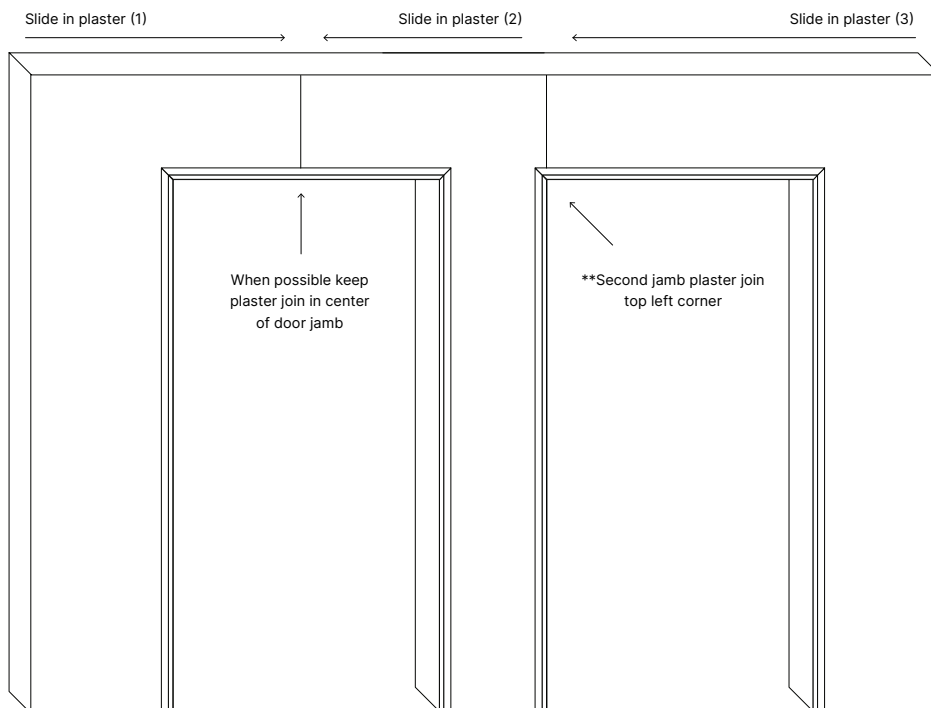
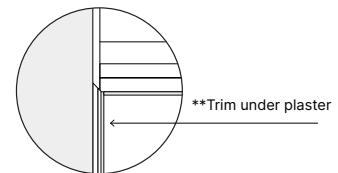

PLASTER

CORNER TRIM

REQUIRED TOOLS - NOT SUPPLIED



EAR PROTECTION



EYE PROTECTION



12MM PACKER STRIP



PENCIL

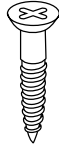

25MM SCREWS

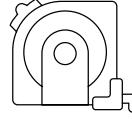

TAPE MEASURE

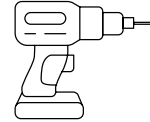

DRILL

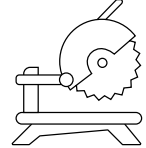

DROP SAW

STEP 1: MEASURE

Measure window Jamb.

Mark your measurements on your ME TRIM shadowline trim.

**** When using the corner trim, ME TRIM is to be cut straight and allow 3-5mm for corner trim.**

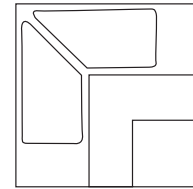

CORNER TRIM

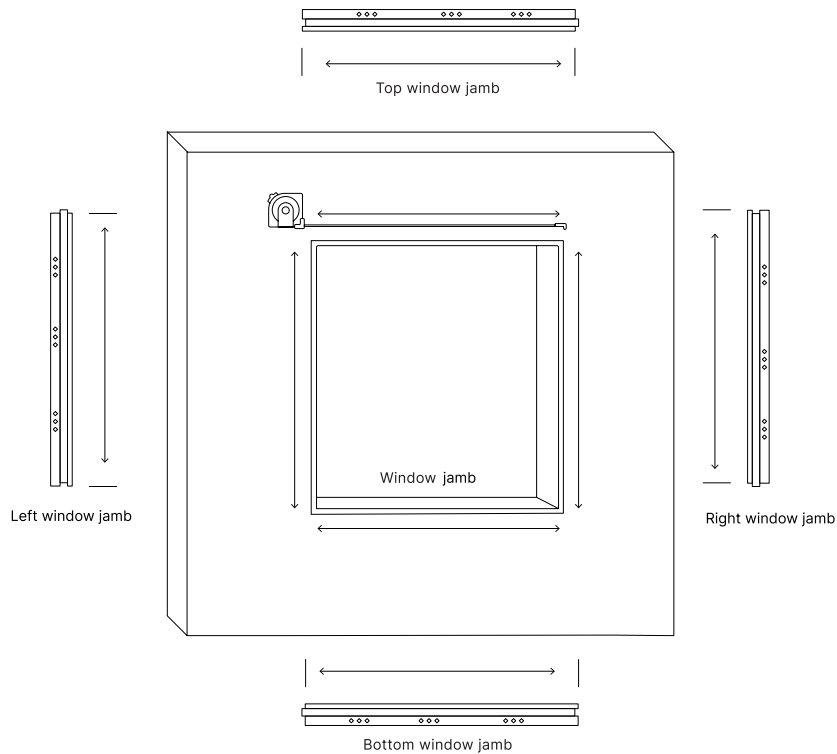

STEP 2: INSTALL

When applying to windows and doors, slot the corner trim into place and then attached to door or window frame.

Corner trim offers a greater tolerance for square edges and is ideal for DIY projects and renovations where windows and doors may not be perfectly plumb.

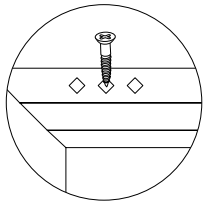

Attach ME TRIM to the frame and leave the corner piece loose to accommodate movement. The corner piece will be secured in place by the trim.

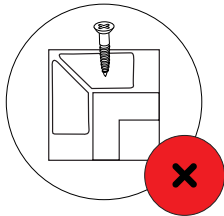

→ Then proceed to **step 4** under windows and doors.

DOOR

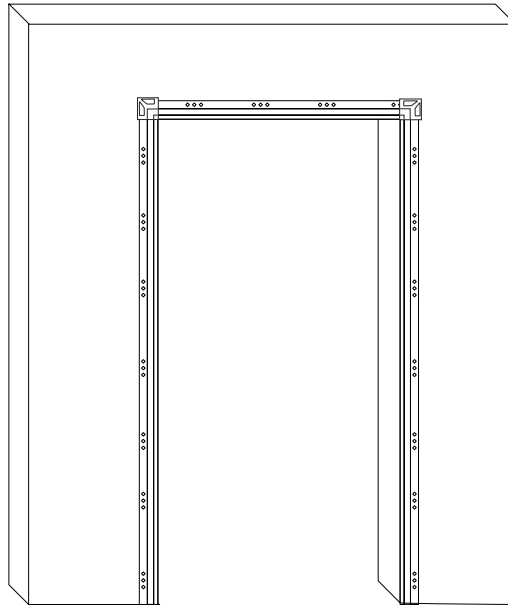

WINDOW

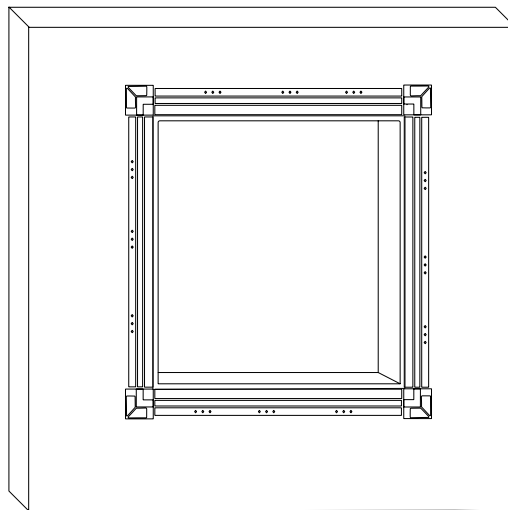

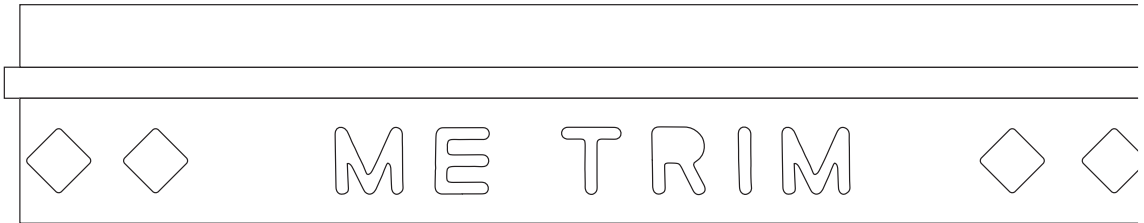
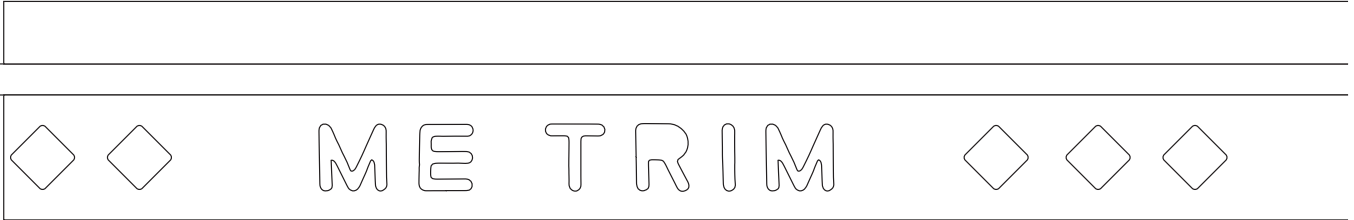

METRIM

Our customer service team is on standby to answer product questions and help with installation to ensure exceptional results for every project. Request a personal consultation or virtual product demo via Zoom to understand how METRIM will benefit your building project.

Contact	1800 962 263 info@metrim.com.au www.metrim.com.au
Office	5 Powell Way Cranbourne West 3977
Factory	4/21-23 Futures Rd Cranbourne West 3977