

SHADOWLINE TRIM

SERIES BY **ME**TRIM

INSTALLATION
DOORS, WINDOWS AND CORNERS

TILE TRIM

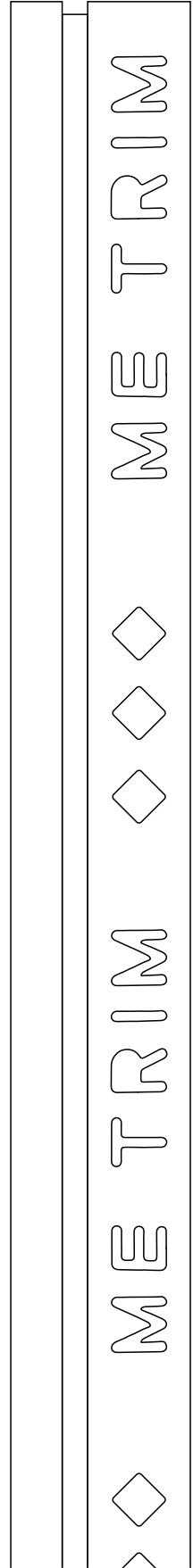
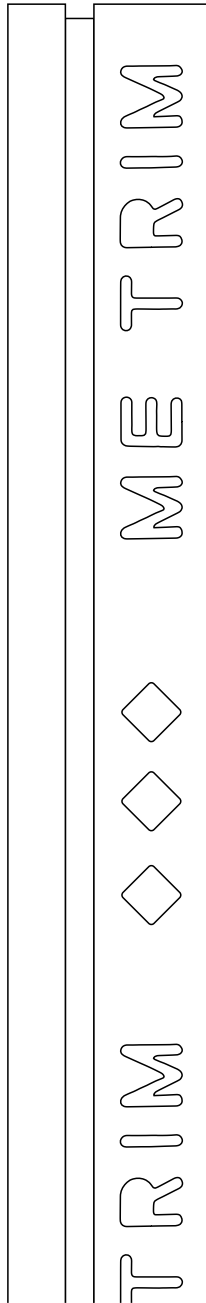
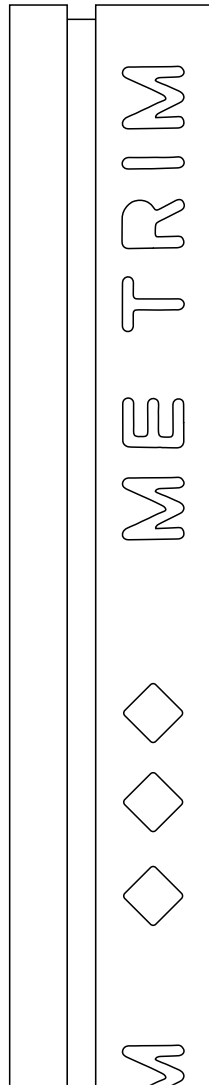

SHADOWLINE TRIM

This installation guide offers comprehensive instructions for fitting ME TRIM tile trim around doors, windows, and corners, suitable for both Plasterboard or Villaboard. It details preparation, necessary tools, and provides step-by-step directions for measuring, cutting, and securing the trim to ensure professional results. The guide emphasises proper techniques and includes customer service support for additional help and personalised consultations. Ideal for ensuring precise and polished finishes in tiling projects.

BEFORE YOU START!!

Please note that all ME TRIM products are supplied with a protective film. This should not be removed until the tiling and painting of the jambs are complete.

TILE TRIM	DOOR TRIM	
------------------	------------------	--

PREPARATION

Before beginning ME TRIM installation, it is important that the door frame is prepared correctly. This can differ depending on the use of Plasterboard or Villaboard, due to the difference in thickness. Please see below to ensure your door frame is correct before installing your ME TRIM Shadowline Trim.

PLASTERBOARD

When using plasterboard, please ensure the door frame has been prepared correctly as pictured.

There must be a minimum of 12mm gap between the plasterboard and the door jambs on every side of the door frame.

Fit plaster sheet to wall frame leaving a 12mm gap between the door jamb and the wall plaster. The plaster may also be cut out at the time of ME TRIM installation.

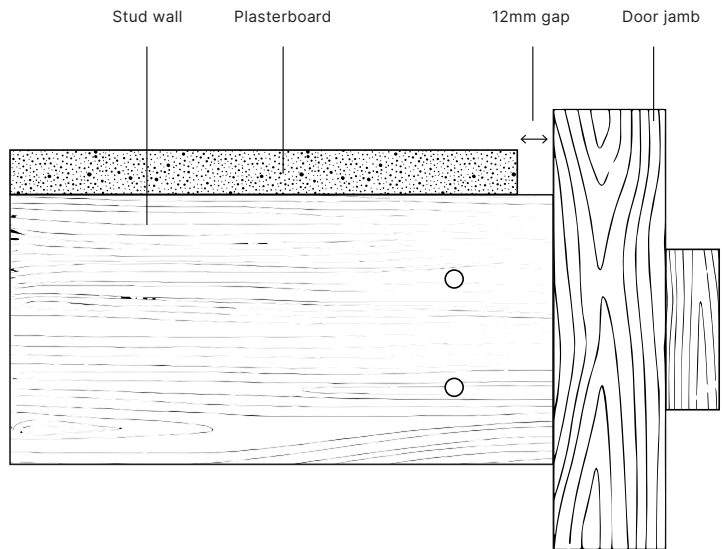

VILLABOARD

When using Villaboard, please ensure the door frame has been prepared correctly as pictured.

There must be a 12mm gap between the villaboard and the door jambs on every side of the door frame.

Fit 12mm x 30mm x 75mm horizontal wooden spacers to the building wood frame in the door way area.

It is recommended to use 1 x 12mm x 30mm x 75mm horizontal wooden spacer every 50cm, with two nails on each side approximately 20mm from each left and right side.

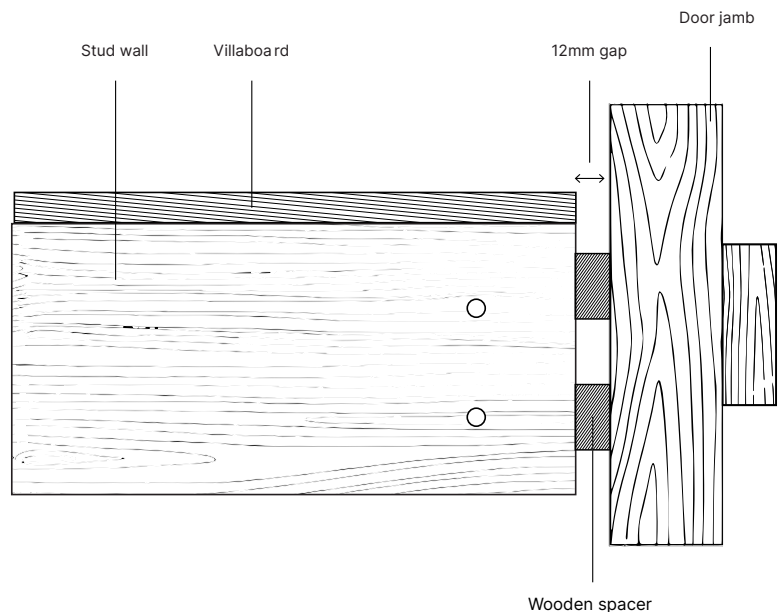

REQUIRED TOOLS - NOT SUPPLIED

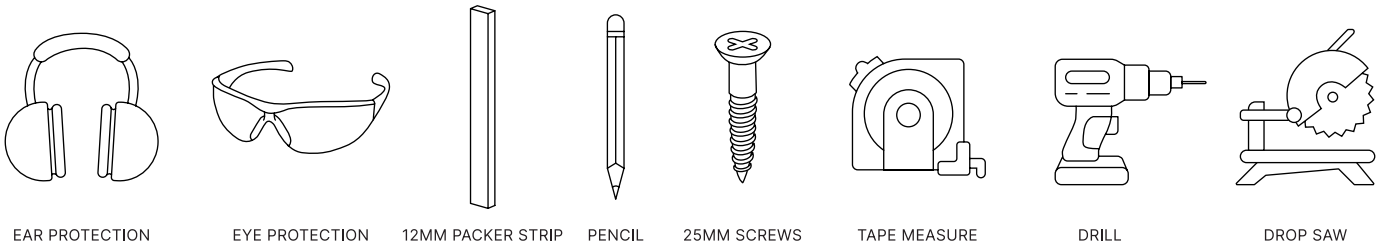

STEP 1: MEASURE

Measure door frame. Take your measurement from the outside of the door jambs.

Mark your measurements on your ME TRIM shadowline trim.

This example uses Box Series trim.

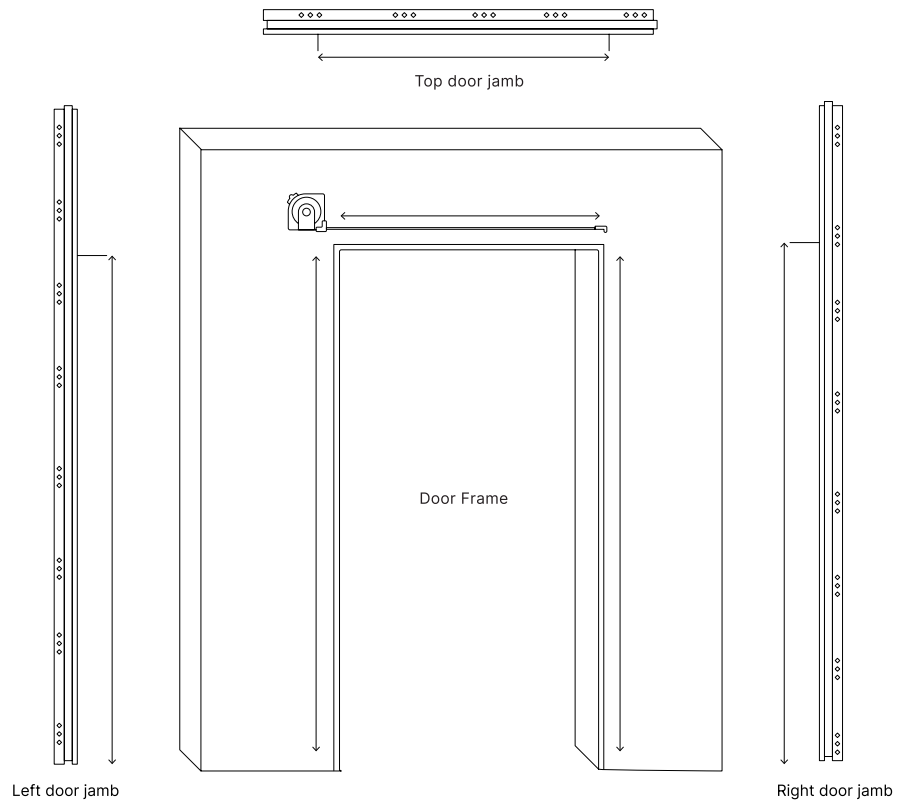

Make sure to make your mark on the edge of the ME TRIM closest to inside of the door (as pictured).

*The side with the screw holes will face away from the door frame on each side with the top of the "M" on ME TRIM facing the inside of the door.

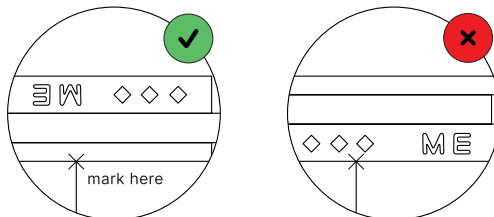

TILE TRIM	DOOR TRIM	
------------------	------------------	--

STEP 2: CUT TOP LENGTH

Place your top door jamb ME TRIM length on the drop saw table, place the **12mm packer strip*** under the ME TRIM to keep it level.

Before cutting ensure your **blade is sharp**, your dropsaw is straight and at a perfect 45° angle.

Using the drop saw, prepare cutter to 45° angle and cut at 45° on both sides.

Once cut, the longest part of your ME TRIM length should be the side with the screw holes.

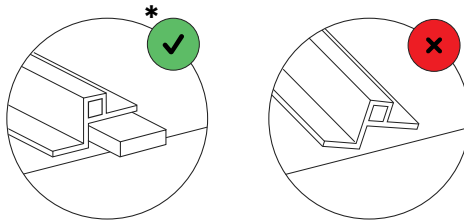

*** MUST USE 12MM PACKER FOR CORRECT CUT**

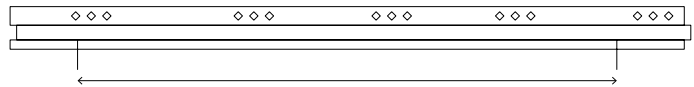

STEP 3: CUT SIDE LENGTHS

Repeat this step, cutting the side lengths of your ME TRIM.

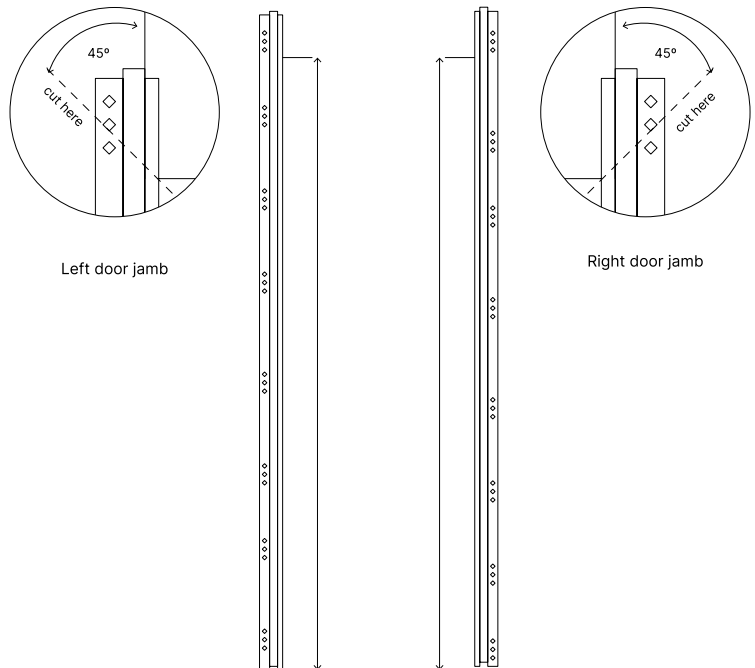

ALTERNATIVE CUT METHOD

ME TRIM can alternatively be cut at a 90° angle. After measuring and cutting the length of the door frame, and addition pieces is cut from one side of the join and the second trim is placed flush adjacently. If this method is preferred, please measure and cut accordingly. This only applies at BOX and L Series trim.

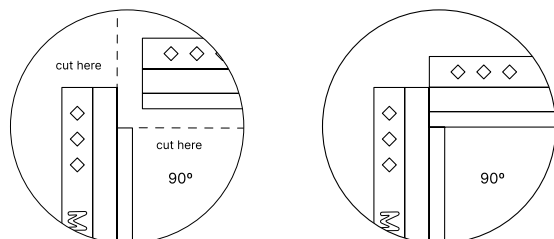

STEP 4: SCREW IN PLACE

Fit the ME TRIM tile trim to the plaster or Villaboard, placing the inside edge of the ME TRIM in the 12mm gap between the door jam and wall.

The ME TRIM logo and small screw holes are to be on the face of the plaster or Villaboard.

Using 25mm screws to fix the ME TRIM. The screws must penetrate the wood wall frame, it is recommended to use 1x25mm self tapping screws every 50cm.

NB. For a stronger fixing, it is recommended—but not mandatory—to apply polyurethane adhesive for initial positioning of the trims before securing them with screws.

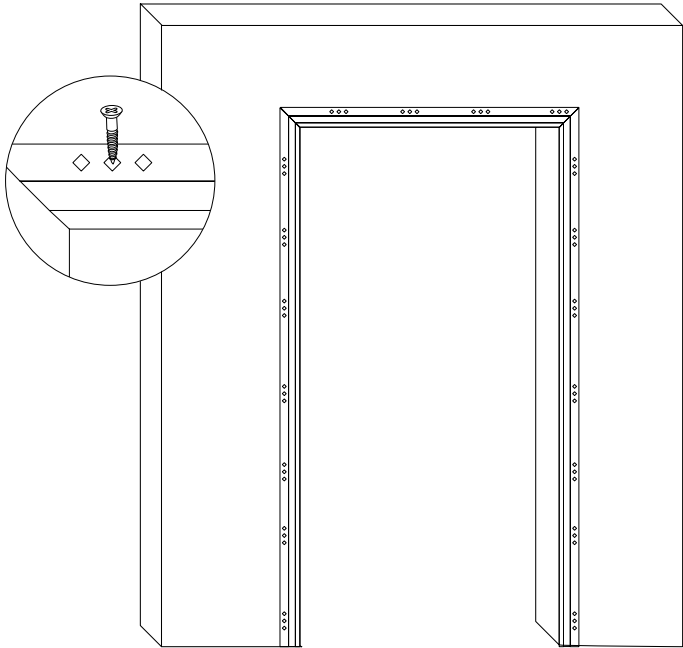

STEP 5: TILE

Once the ME TRIM tile trim is fixed to the plaster or Villaboard area around the door way, glue and tile over the top of the ME TRIM tile trim.

To account of the small 1mm lip on the ME TRIM, tile adhesive can be built up slightly to ensure a level finish.

Please note, tile grout can be applied onto ME TRIM, OR tiles can be installed directly to the edge of ME TRIM.

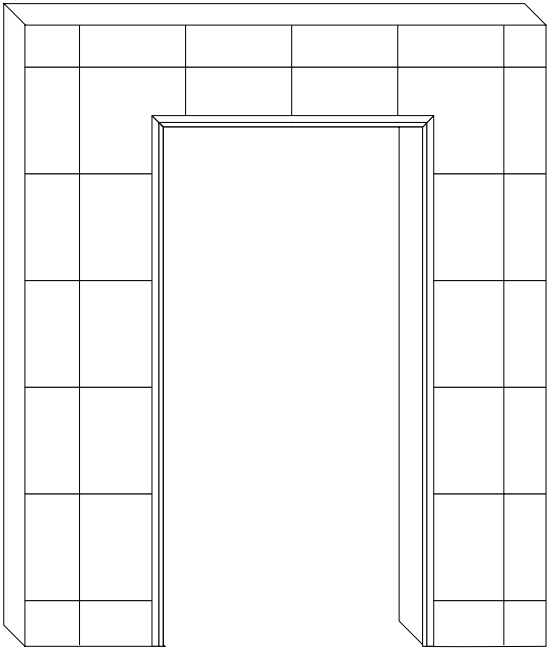

TILE TRIM	WINDOW TRIM	
------------------	--------------------	--

PREPARATION

Before beginning ME TRIM installation, it is important that the window frame is prepared correctly. This can differ depending on the use of Plasterboard or Villaboard, due to the difference in thickness. Please see below to ensure your window frame is correct before installing your ME TRIM Shadowline Trim.

PLASTERBOARD

When using Plasterboard, please ensure the window frame has been prepared correctly as pictured.

There must be a minimum of 12mm gap between the plasterboard and the window jambs on every side of the window frame.

Fit plaster sheet to wall frame leaving a 12mm gap between the window jam and the wall plaster. The plaster may also be cut out at the time of ME TRIM installation.

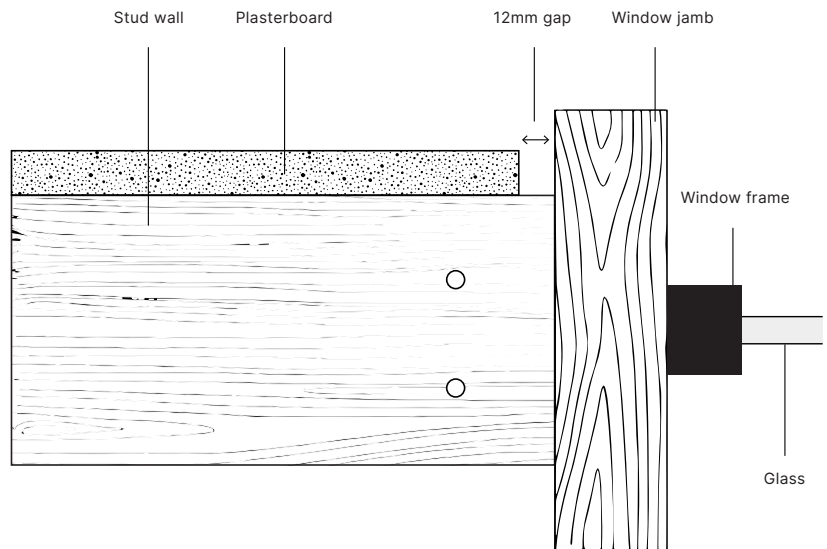

VILLABOARD

When using Villaboard, please ensure the window frame has been prepared correctly as pictured.

There must be a 12mm gap between the villaboard and the door jambs on every side of the window frame.

Fit 12mm x 30mm x 75mm horizontal wooden spacers to the building wood frame in the door way area.

It is recommended to use 1 x 12mm x 30mm x 75mm horizontal wooden spacer every 50cm, with two nails on each side approximately 20mm from each left and right side.

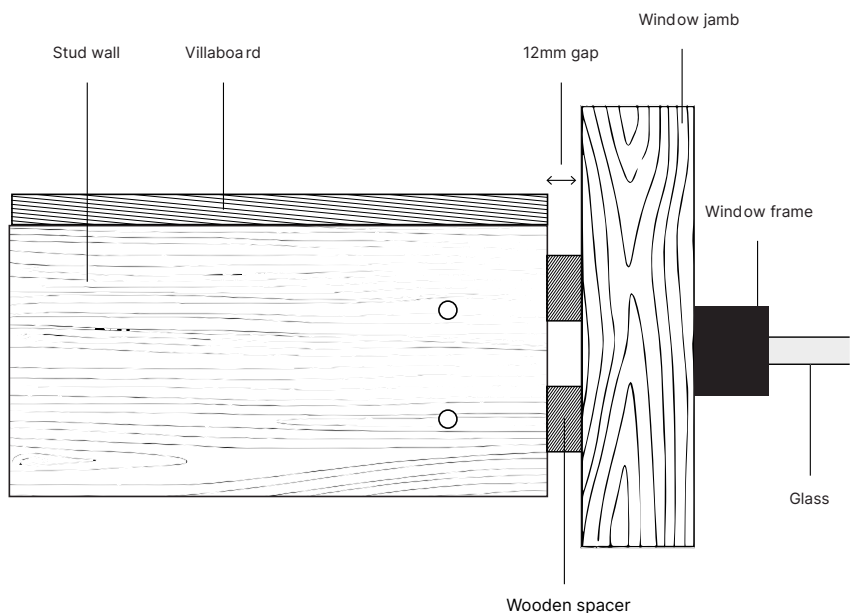

TILE TRIM	WINDOW TRIM
------------------	--------------------

STEP 2: CUT TOP LENGTH

Place your top window jamb ME TRIM length on the drop saw table, place the **12mm packer strip*** under the ME TRIM to keep it level.

Before cutting ensure your **blade is sharp**, your dropsaw is straight and at a perfect 45° angle.

Using the drop saw, prepare cutter to 45° angle and cut at 45° on both sides.

Once cut, the longest part of your ME TRIM length should be the side with the screw holes.

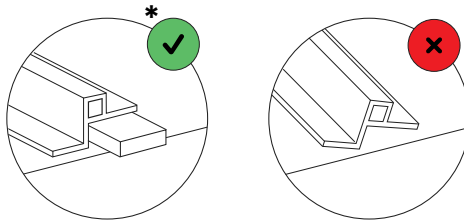

*** MUST USE 12MM PACKER FOR CORRECT CUT**

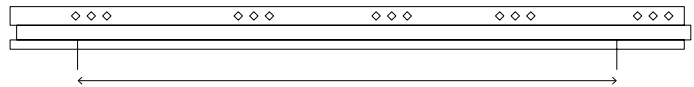

STEP 3: CUT SIDE LENGTHS

Repeat the cutting process on the left, right and bottom window jamb ME TRIM lengths.

Make sure the side with the screw holes is facing away from the window on each side.

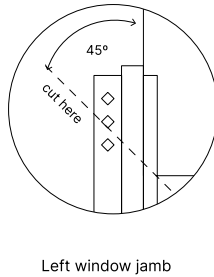
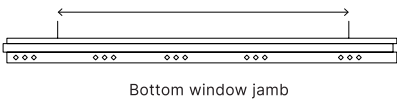

Left window jamb

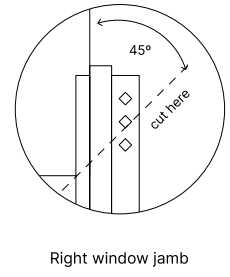

Right window jamb

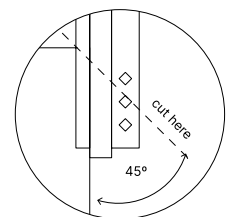
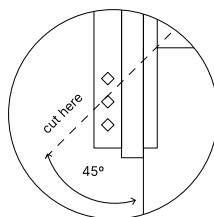
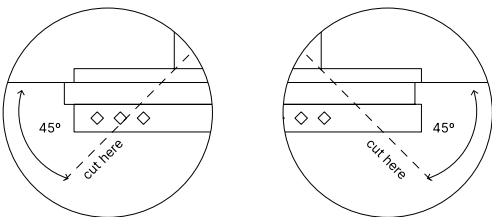

ALTERNATIVE CUT METHOD

ME TRIM can alternatively be cut at a 90° angle. After measuring and cutting the length of the window frame, and addition pieces is cut from one side of the join and the second trim is placed flush adjacently. If this method is preferred, please measure and cut accordingly. This only applies at BOX and L Series trim.

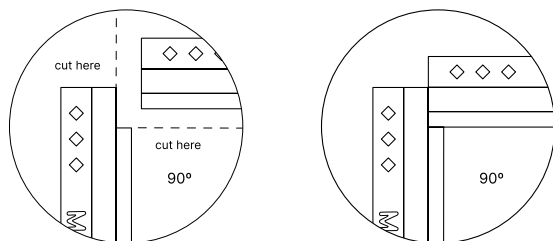

TILE TRIM	WINDOW TRIM	
------------------	--------------------	--

STEP 4: SCREW IN PLACE

Fit the ME TRIM tile trim to the plaster or Villaboard, placing the inside edge of the ME TRIM in the 12mm gap between the window jam the wall.

The ME TRIM logo and small screw holes are to be on the face of the plaster or Villaboard.

Using 25mm screws to fix the ME TRIM. The screws must penetrate the wood wall frame, it is recommended to use 1x25mm self tapping screws every 50cm.

NB. For a stronger fixing, it is recommended—but not mandatory—to apply polyurethane adhesive for initial positioning of the trims before securing them with screws.

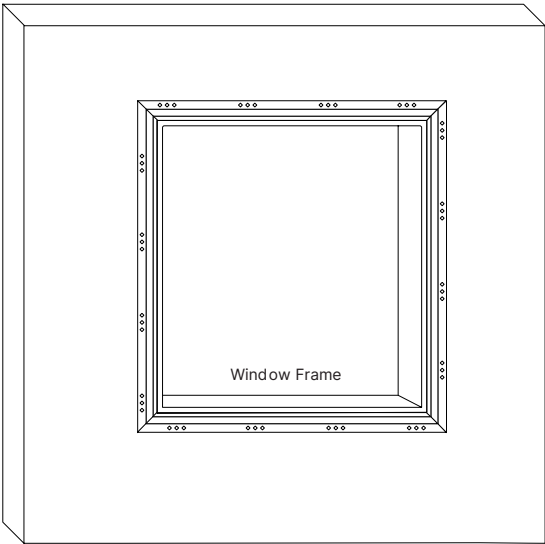
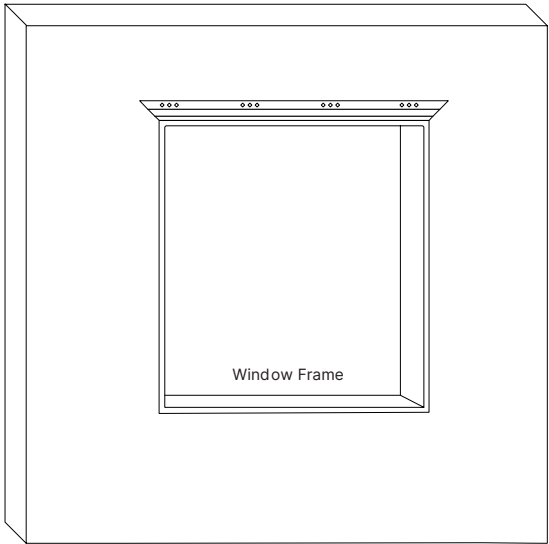
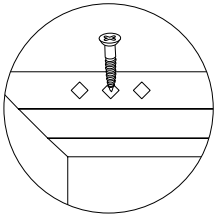

STEP 5: TILE

Once the ME TRIM tile trim is fixed to the Plaster or Villaboard area around the window, glue and tile over the top of the ME TRIM tile trim.

To account of the small 1mm lip on the ME TRIM, tile adhesive can be built up slightly to ensure a level finish.

Please note, tile grout can be applied onto ME TRIM, OR tiles can be installed directly to the edge of ME TRIM.

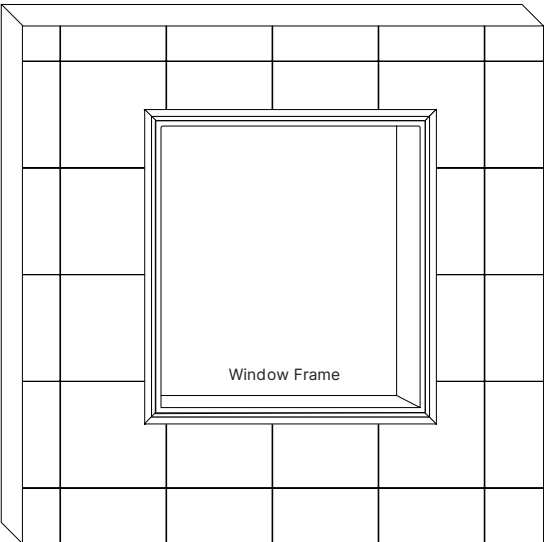

TILE TRIM	CORNER TRIM	
------------------	--------------------	--

REQUIRED TOOLS - NOT SUPPLIED

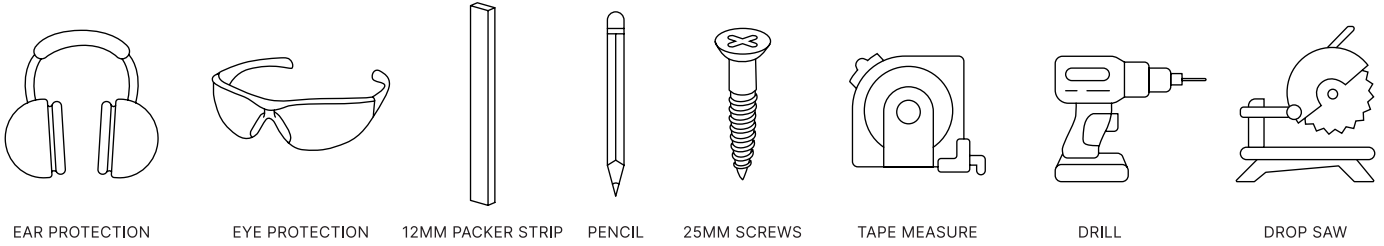

EAR PROTECTION EYE PROTECTION 12MM PACKER STRIP PENCIL 25MM SCREWS TAPE MEASURE DRILL DROP SAW

STEP 1: MEASURE

Measure window frame.

Mark your measurements on your ME TRIM shadowline trim.

**** When using the corner trim, ME TRIM is to be cut straight and allow 3-5mm for corner trim.**

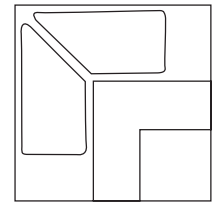

CORNER TRIM

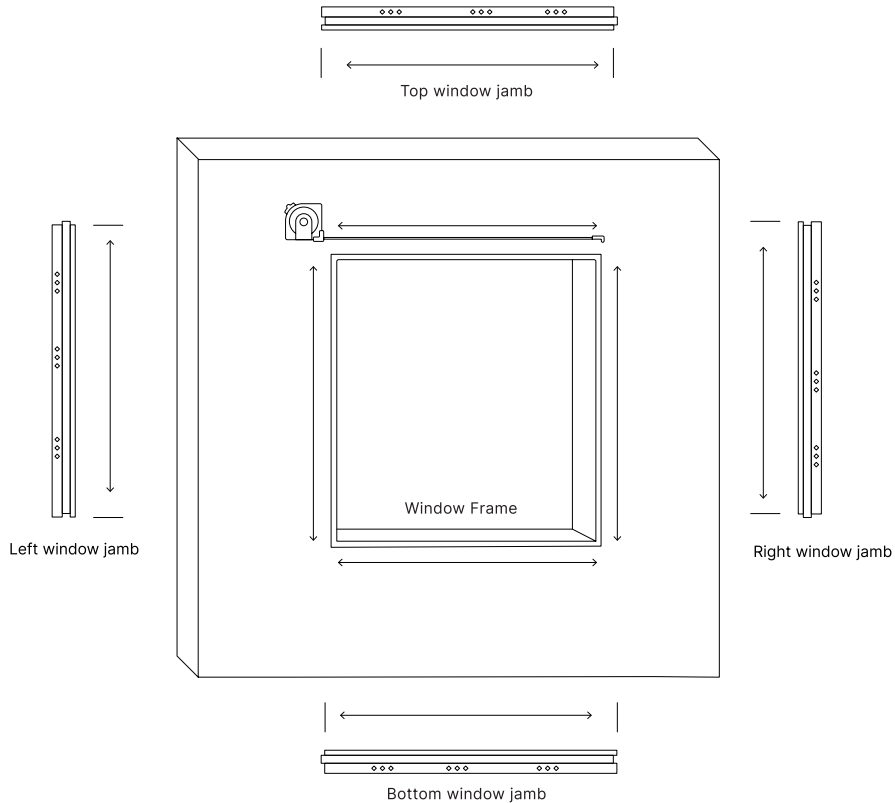

STEP 2: INSTALL

When applying to windows and doors, slot the corner trim into place and then attached to door or window frame.

Corner trim offers a greater tolerance for square edges and is ideal for DIY projects and renovations where windows and doors may not be perfectly plumb.

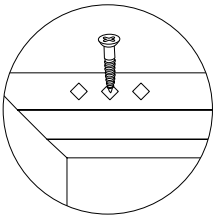

Attach ME TRIM to the frame and leave the corner piece loose to accommodate movement. The corner piece will be secured in place by the trim.

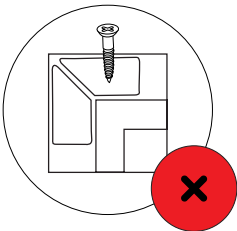

DOOR

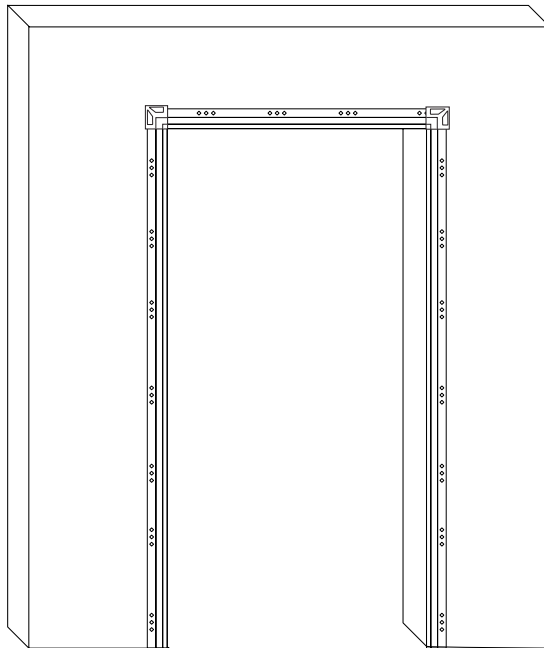

WINDOW

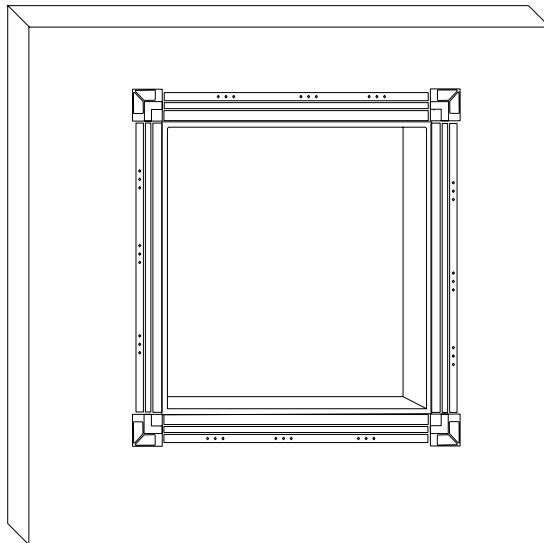

→ Then proceed to **step 4** under windows and doors.

TILE	WATER PROOFING	
-------------	-----------------------	--

Waterproofing should be completed during the framing stage, prior to installing the jambs. Once this is complete, the jambs can be installed, followed by the ME TRIM, and then tiling.

*If the jambs are already installed, allow a gap for the shadowline indent and fill it with silicone before installing the ME TRIM.

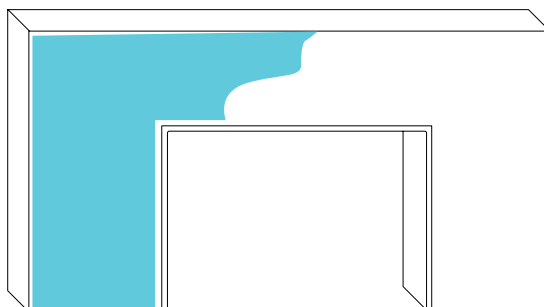

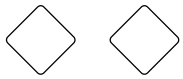

ME TRIM

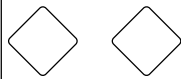
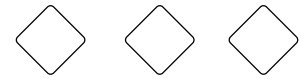

ME TRIM

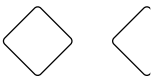

METRIM

Our customer service team is on standby to answer product questions and help with installation to ensure exceptional results for every project. Request a personal consultation or virtual product demo via Zoom to understand how ME TRIM will benefit your building project.

Contact 1800 962 263
info@metrim.com.au
www.metrim.com.au

Office 5 Powell Way
Cranbourne West 3977

Factory 4/21-23 Futures Rd
Cranbourne West 3977